

DUALTRON
VICTOR LUXURY +
Personal Mobility
PRODUCT MANUAL

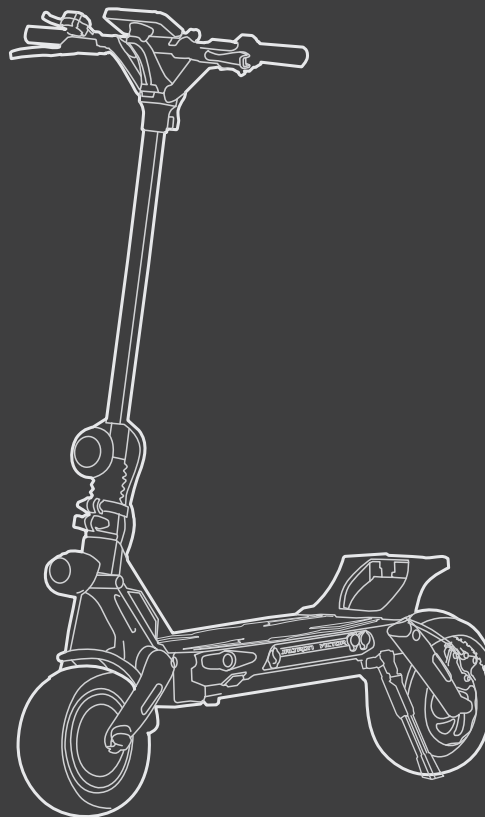



Scan the QR code to download the latest user materials
and obtain the latest updates and safety instructions.

DUALTRON

The dream of electric technology.

Pictures for reference only, subject to our existing products.

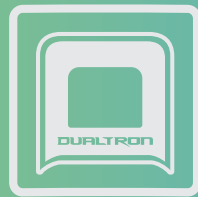

MINIMOTORS





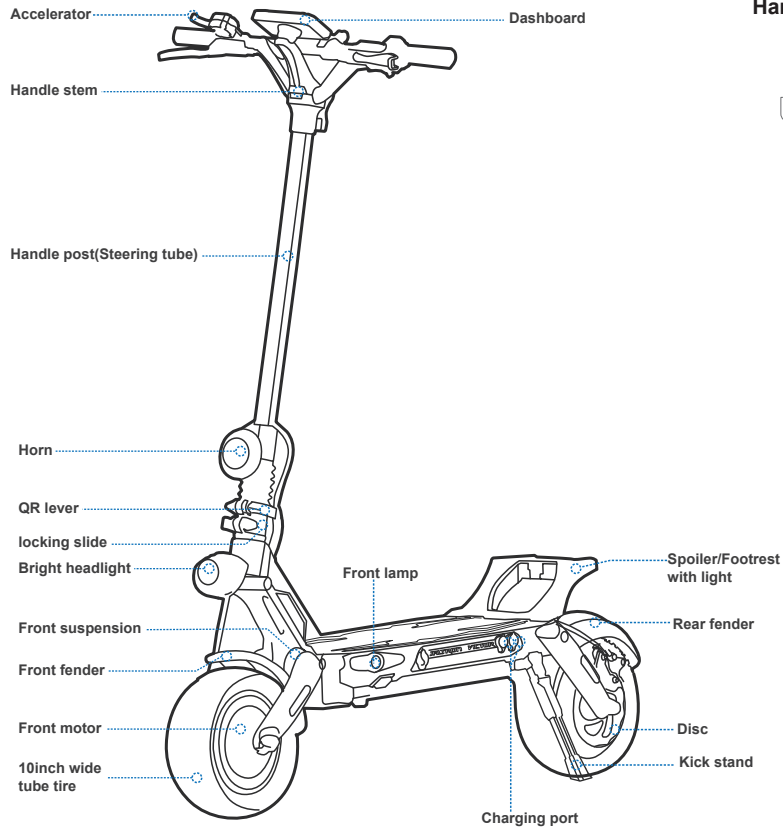

Diagram And Functions

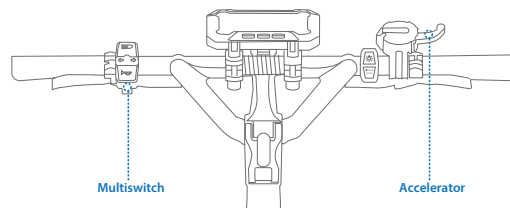

Handlebar Functions



Name	Function	Operation method
 Headlight button	Turn on/off headlight	Press the light button, turn on/off the headlight.
 Turn Signal Button	Turn on/off the left/right signal	Press the left/right side of the Turn Signal Button, the left/right turn signal will keep blinking.
 Horn Button	Turn on the horn	Press the Horn Button, the scooter will beep once.
 LED lamp button	Turn on/off LED lamp	Press the button, turn on/off the LED lamp .
 Motor system selection button	Enable SINGLE/ DUAL drive mode	Switch modes through pressing the button.
Accelerator	Speed up	Pull the throttle to accelerate.







Specifications

	Item	Parameter
Product	Model	Dualtron Victor luxury+
Battery	Battery Capacity	60V28Ah CN / 60V35Ah (LG or Samsung)
	Range	90km / 110km
	Charging Ambient Temperature	0 to 40°C (Battery temperature exceeds 55°C, BMS start protection program.)
	Battery Management System	Over-heating, short circuit, over-current, over-discharge and over-charge protection
Rider	Max. load	120kg
	Recommended Age	14–60 years old
Display	Type	EY4 LCD Bluetooth Display(Ability to connect to DUALTRON APP)
Motor	Motor Type	BLDC Hub Motor
	Nominal Power	1300w*2
Machine	Net Weight	37.4 kg
	Max. Slope	Around 70% (35°)
	Drive System	Single/ Dual drive
	Speed	25km/h
	Length × Width × Height	1170x620x1370mm
	Folded: Length × Width × Height	1170x279x560mm
	Wheelbase	Approx.940mm
	Ground Clearance	Approx.180mm
	Traversable Terrain	Asphalt/flat pavement; obstacles < 5 cm; gaps < 5 cm
	Operating Temperature	-5 to 45°C
	Storage Temperature	-20 to 50°C



Specifications

Brake	Type	Hydraulic Brake
	Electric Brake	ABS&EBS (Indicating the battery temperature exceeds 55°C,BMS start protection program,ABS/EBS fails.)
Charger	Input Voltage	100-120V/200-240V~
	Max. Output Voltage	66.4V 1.7A
Tire	Type	10inch wide tube tire
	Tire Pressure	50 psi
	Material	Rubber
Suspension	Type	F&R suspension cartridge (replaceable)
	Optional	(Default) Softest  Medium soft  Medium  Medium hard  Hardest 

*Disclaimer: this is not a legal opinion or legal advice. The information provided herein (including in the App) is for your convenience and information purpose only. It is not intended to cover every piece of law and/or regulation that may be applicable to this product. DUALTRON explicitly hereby disclaims any and all warranty and/or representation, express or implied, related to completeness, accuracy, up-to-date of such information. DUALTRON reserves the right but not obligation to correct, implement and/or update the information. You shall use the information at your own risk. It is your sole responsibility to learn and understand any and all the law and/or regulation, requirements, prohibition, restriction and/or limitation imposed by either law, government authority, court, private party or the others that may apply to your use of this product.

*Theoretical Range: tested while riding with a full battery, 75 kg load, 25°C, at the speed of 25 km/h on average on pavement.

*Typical Range: tested while riding with a full battery, 75 kg load, 25°C, at the speed of 50 km/h on average on pavement. (Some of the factors that affect range include speed, number of starts and stops, ambient temperature, etc.)

*Max.Speed: tested while riding with a full battery,75kg load,25°C,straight road on flat road with no wind. (Some environmental factors can affect max speed,uneven roads, crooked roads, temperature, wind, etc.)



Packing List

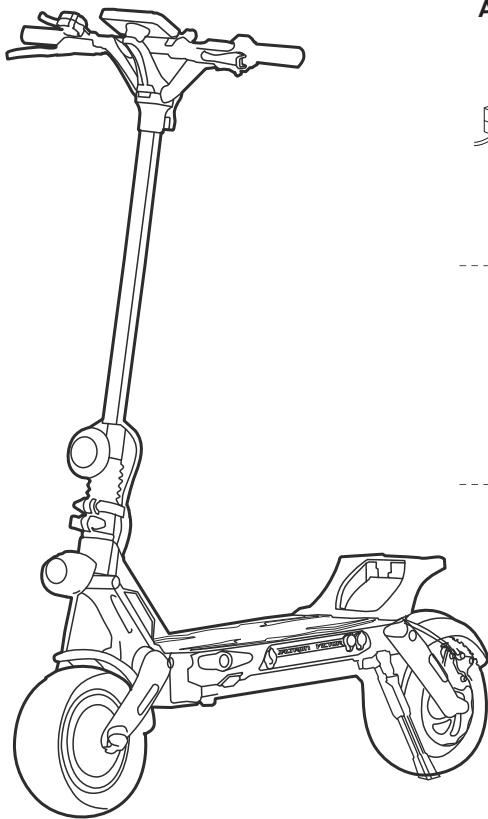

Accessories



Battery charger x1



Manual



Screw Cap x 2

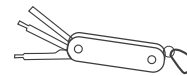

Multitool x 1



Bluetooth Connection

APP Download Guide

Method 1

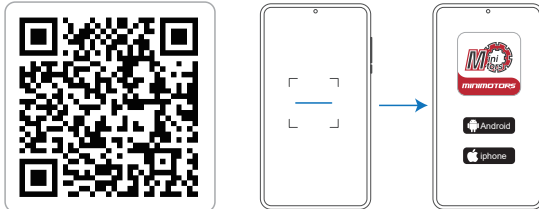

- 1.Scan the QR code to download the APP.
- 2.Choose the mobile phone system that suits you to install,and register / log in.

Method 2

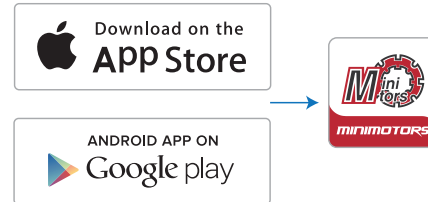

- 1.Search "DUALTRON" in the application and download it, and register / log in.

Pair the Bluetooth on the APP

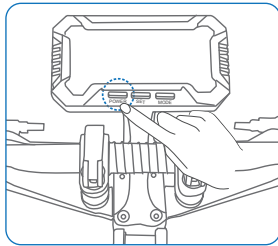

Power on the scooter.

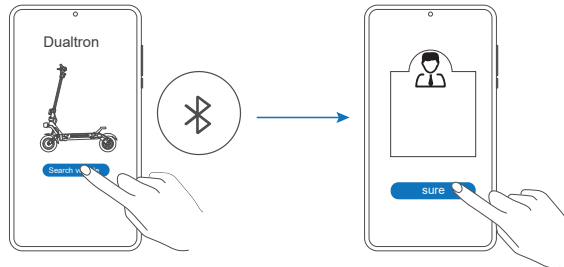

Click "Search vehicle" and pair with your scooter. * The scooter is connected to the Dualtron app when the Bluetooth symbol lights up.

Select "bind as owner".
(No one else can connect, only people authorized by you are allowed to connect. Authorizations are created on the app.)



Assembly

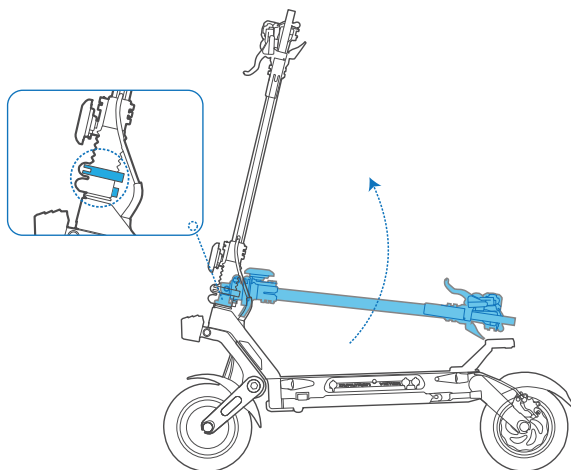

- ① Release the QR lever, raise the locking slide upwards, raise the steering tube, then lower the locking slide downward.
- ② Tighten the finishing screw properly to lock the QR lever so that the locking slide is firmly fixed in any direction, and check for looseness during use.

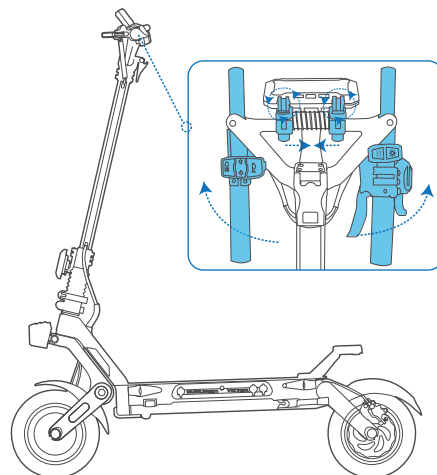

- ① Loosen the QR lever, pull the locking slide inward and raise the handlebar, then close the QR lever and tighten the set screw.
- ② Place the locking slide up to the safety line and lock it so that it is firmly fixed with the QR lever. Always check for looseness during use.



How to Ride

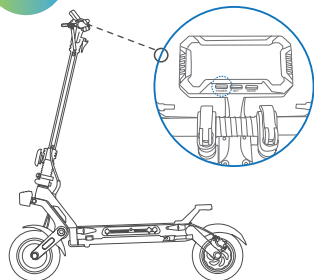

1. Power on the scooter and choose the speed mode. * Please choose the speed mode before riding! Note: Speed mode can be choose via the Dualtron app.



2. Stand on the footboard with one foot and push off with the other foot to start gliding. *Make sure you have disabled SAFE mode.(SAFE mode setting via Dualtron app.Deactivate safe mode by squeezing brake lever.)

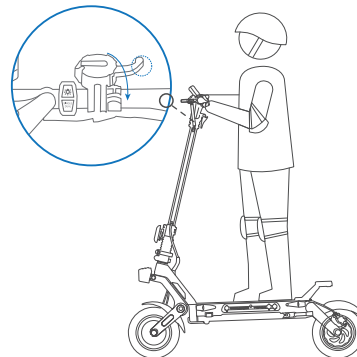

3. Put both feet on the footboard and stand stably. Pull the throttle to speed up.

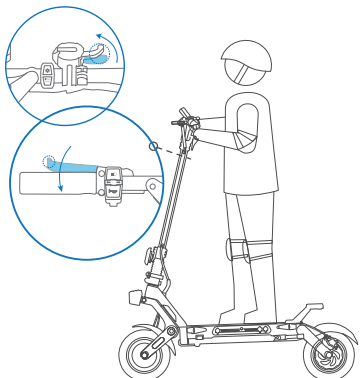

4. Slow down by releasing the throttle and squeezing brake levers.

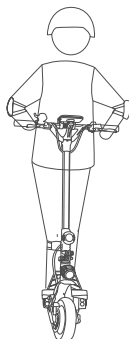

5. To turn, shift your body and turn the handlebar slightly. * Please watch out for road conditions, sufficient turning space is required.

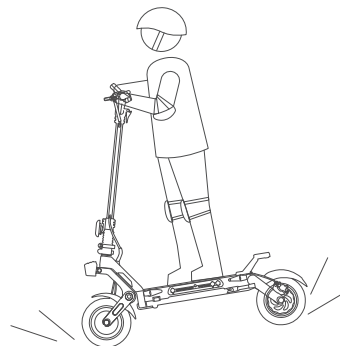

When hard braking, serious danger or injury may occur. Maintain a moderate speed and look out for potential hazards.



Folding

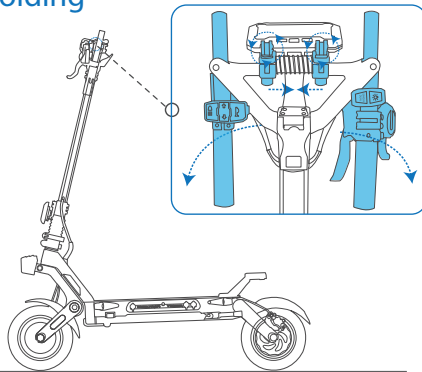

Loosen the QR lever, push the locking slider inward and fold the handlebars down.

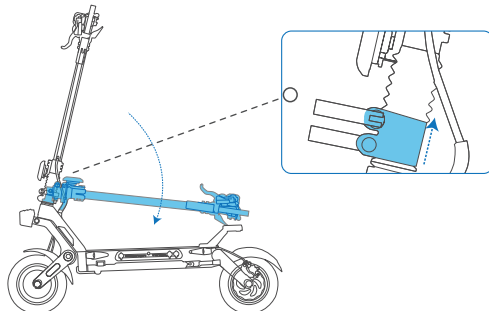

Lay the steering tube down while raising the locking slide.

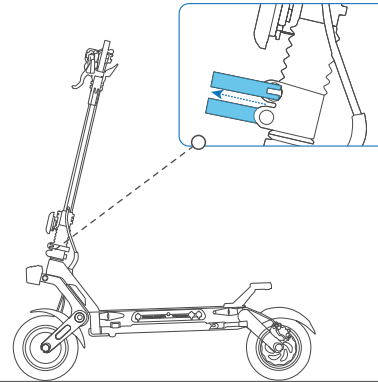

Loosen the QR lever and move the locking slide upward.
⚠ You must hold the steering tube with your hand to prevent falling down and hitting.

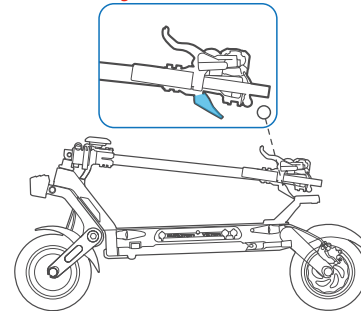

Lock the handlebar hook to the footrest.
⚠ Ensure that lock the handlebar when lift scooter.

